

|                   |   |
|-------------------|---|
| العنوان:          | Model for Theoretical Study of Currents in the Sirte Gulf                                       |
| المصدر:           | مجلة الجامعي  |
| الناشر:           | النقابة العامة لأعضاء هيئة التدريس الجامعي  |
| المؤلف الرئيسي:   | Al Muhyi, Abd Alhaleem A.   |
| المجلد/العدد:     | ع17   |
| محكمة:            | نعم   |
| التاريخ الميلادي: | 2009  |
| الشهر:            | مارس  |
| الصفحات:          | 60 - 37   |
| رقم MD:           | 770507  |
| نوع المحتوى:      | بحوث ومقالات  |
| قواعد المعلومات:  | EduSearch   |
| مواضيع:           | الظواهر الطبيعية، التيارات المناخية، الطقس والمناخ، خليج سرت، ليبيا                             |
| رابط:             | <a href="http://search.mandumah.com/Record/770507">http://search.mandumah.com/Record/770507</a> |

# Model for Theoretical Study of Currents in the Sirte Gulf

Dr. AbdulHaleem A. Al Muhyi  
Faculty of Science Al-Fath University

## ABSTRACT:

Sirte Gulf has a very important position for Libya , most of the Libyan commercial and oil ports are located on its coast and according to this importance, we study the current in the Gulf. It has been applied a vertically integrated hydrodynamic model to study wind and tide driven current in the Gulf, the results of the experiments show that the current generated due to wind stress or combination of wind stress and tide forcing is weak near the coastline while the current in the center of the Gulf or farther from coastline is strong.

## Introduction

Libya occupied an individual position by possessing five oil ports, all that ports are located on the coast line, four of them are located in the region which has a coast line extending about 300 km on the Sirte Gulf (Mohamed M. Al-Mahdy, 1990), fig.(1)

---



Fig.(1) Gulf of Sirte. commercial and oil ports. 1- Brayqah port 2- As Sidar port  
3- Ra's Lanuf port 4- Az Zuwaytinah (Great world Atlas)

The Sirte Gulf itself exhibits a very large, concave appearance within the Libyan coast. It extends from about latitude  $32^{\circ} 55'$  N, on the northern edge of Libya, to about latitude  $30^{\circ} 15'$  N. on southern edge of the Gulf, it has a coastline approximately 700 kilometers (434 miles) long (salem, 1967). Also it has a maximum depth (3580) meter [see the Bathymetry of the

Gulf fig(2a)] (International Chart Series Mediterranean Sea, 1993).

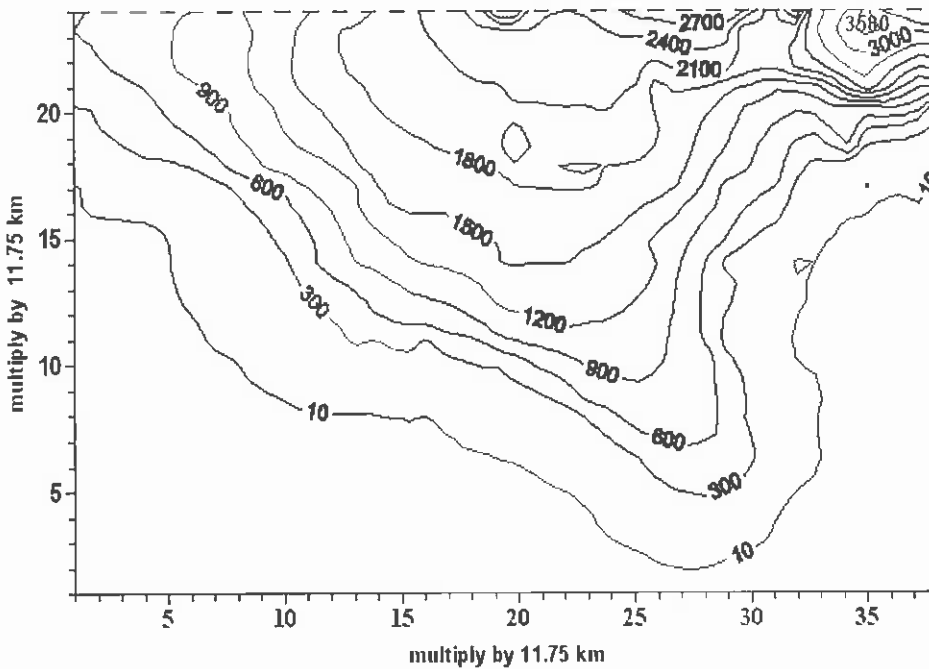

Fig (2a) Bathymetry of Sirte Gulf

The four ports which are located on the Gulf are as follow

1- Brayqah port 2- As Sidar port 3- Ra's Lanuf port 4- Az Zuwaytinah port. Except of Burayqah port and Ra's Lanuf port still right now the importance of oil ports in Libya concentrates on an export of crude oil while Burayqah and Ra's Lanuf have another importance similar to industry activities after issues some new industry like liquid gas and petrochemical. So that Sirte Gulf is regarded to Libya as the only important marine way for export of crude oil and the industry production to all world countries (Mohamed M. Al-Mahdy, 1990). And according to this importance, it is necessary to study the current in the Gulf which is driven by the wind and astronomical tide which in turn has an effect on the navigation in the Gulf. So, in this paper, it has been applied a vertically

integrated hydrodynamic model to study wind driven current and cooperation tide in the Gulf.

### **Objective of this study**

The principle objective of this study is to take some calculation based on a numerical hydrodynamical model, of the respective effects of wind and tidal oscillation on the currents in the Sirte Gulf.

### **Review of the model**

Two dimension vertically integrated hydrodynamic models now became well-grounded and have been widely used to solve a large number of oceanographic problems. The application of these models was by Jelesnianski (1962 , 1966 , 1967 , 1970 ) in prediction storm surge , the work of Fandry (1981, 1982, 1983 ) in Bass Strat, Australia , and Davies (1988) , a convolution method is developed for computing the bottom stress in vertically integrated hydrodynamic numerical model , also Estoque (1997) studied the tidal and wind-driven currents in Lingayen Gulf. In the different research efforts to model circulation in Louisiana estuaries included applications of a two-dimensional depth-integrated hydrodynamic model to Terrebonne/ Timbalier Basin (Inoue and Wiseman, 2000), Fourleague Bay (Wiseman and Inoue, 1993), Barataria Basin (Park, 1998; Inoue et al., 1998) and Chandeleur / Breton Sound (Inoue et al., 2001). In all those applications, the hydrodynamic model has been carefully tested and calibrated using the observed sea-level and / or current data. In the final report of Coastal Marine Environmental Modeling: Under Part II, a two-dimensional depth-

---

integrated hydrodynamic model, that includes baroclinic pressure gradient, was developed. This model has been applied to various estuaries in Louisiana, namely, Terrebonne / Timbalier Bay, Barataria Bay, Chandeleur - Breton Sound and Fourleague Bay. a simplified version of the hydrodynamic model has been coupled to a simple ecological model that includes suspended sediments, nutrients and phytoplankton, to simulate a spring bloom in Fourleague Bay. In this report, development of a high-resolution integrated hydrology-hydrodynamic model of Barataria Basin was presented. (Park, Inoue, William J. Wiseman, Jr, Justic, Stone 2004). The indications of the accuracy of this model is the fundamental bases to be used in this study.

### **Model description**

We consider a limited portion of earth surface where the effect of curvature could be neglected. The grid system is rectangular set of axes  $Oxyz$  fixed relative to the rotating earth, with  $Ox$  and  $Oy$  in the plane of the undisturbed sea surface  $Oz$  vertically upward. Grid point along  $x$  and  $y$  axis is (38 X 24) with uniform grid distance of (11.750) kilometer. The linearized equations of model consist of the depth-integrated hydrodynamical equation which used to describe the barotropic motion of a homogenous hydrostatic fluid on  $f$ -plane in a shallow water basin are :-

---

- The continuity equation relating the rise and fall of the sea surface elevation to the wind stress and a astronomical tide

$$\frac{\partial \zeta}{\partial t} + \frac{\partial u}{\partial x} + \frac{\partial v}{\partial y} = 0 \text{ -----(1)}$$

- The horizontal component of vertically integrated momentum equations

$$\frac{\partial U}{\partial t} = fV - \frac{1}{\rho_w} [h + \zeta] \frac{\partial p_a}{\partial x} - g [h + \zeta] \frac{\partial \zeta}{\partial x} + \frac{1}{\rho_w} [\tau_{sx} - \tau_{bx}] \text{ -----(2)}$$

$$\frac{\partial V}{\partial t} = -fU - \frac{1}{\rho_w} [h + \zeta] \frac{\partial p_a}{\partial y} - g [h + \zeta] \frac{\partial \zeta}{\partial y} + \frac{1}{\rho_w} [\tau_{sy} - \tau_{by}] \text{ -----(3)}$$

where (u,v) are the horizontal transport components of depth-averaged velocity along (x,y) axis which defined respectively as:

$$U = \int_{-h}^{\zeta} u dz \quad V = \int_{-h}^{\zeta} v dz$$

t is time ; x and y the horizontal co-ordinates ; f is the coriols parameter considered constant ;  $\zeta$  and  $\rho_w$  are the elevation of sea surface above its mean depth and the density of water respectively; h is the undisturbed depth of the sea ;  $P_a$  is the atmospheric pressure ; g the gravitational acceleration ; (  $\tau_{sx}$  ,  $\tau_{sy}$  ) are the components of wind stress ; (  $\tau_{bx}$  ,  $\tau_{by}$  ) are the horizontal components of bottom stress resulting from friction which are evaluated from the horizontal transport components u,v which defined by

$$\tau_{bx} = k \rho_w \frac{U}{h} \quad \tau_{by} = k \rho_w \frac{V}{h}$$

where k is the bottom drag coefficient constant

## The Numerical Model

The domain of interest as shown in figure (2b) land (solid lines) and open boundaries (broken lines) of the model are traced out on the grid approximating as closely as possible those of Sirte Gulf which consists of rectangular strip of coastal sea with dimension (38 X 24) along x axis and y axis respectively and the grid distance is  $\Delta x = \Delta y = 11.750\text{km}$

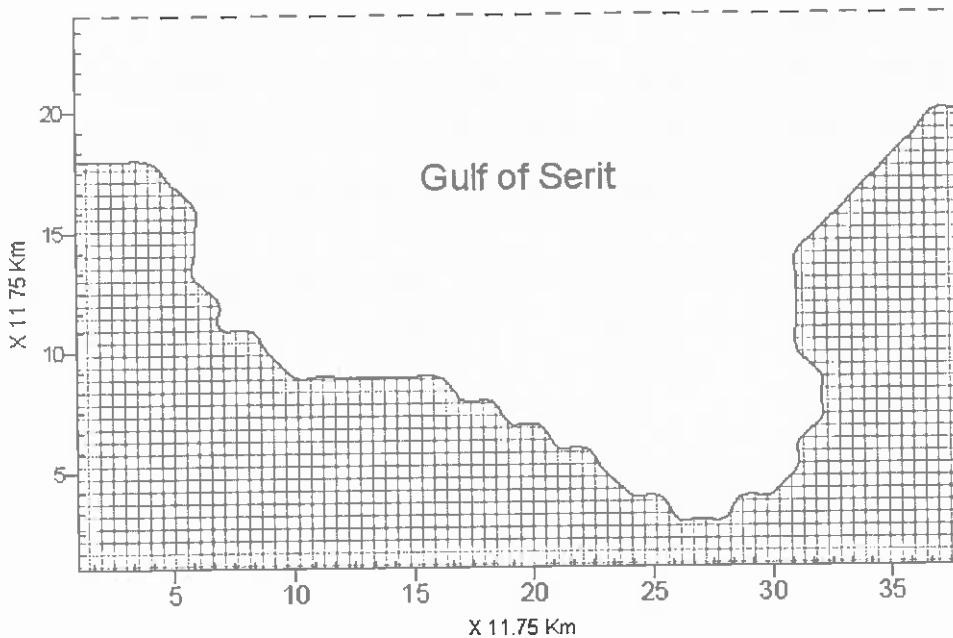

Fig.(2b) The Domain of interest

the finite difference network is an Arakawa C type in which the transport component  $U$  and  $V$  is evaluated at midpoint of  $y$ -direction sides and  $x$ -directed sides respectively. While the sea elevation  $\zeta$  and the still water depth  $h$  is evaluated at center of each grid box figure (3)



an explicit finite difference scheme, using forward time differencing technique to solve for the temporal derivative of  $u, v$  and  $\zeta$  and central space difference technique to solve for the spatial derivative of  $u, v$  and  $\zeta$ , is employed.

### Tidal currents

The longest oceanic waves are those associated with tides and characterized by rhythmic rise and fall of sea-level over a period of several hours. The rising tide is flood whereas the falling tide is ebb. This ebb and flow of tide is manifested in tidal current which can be

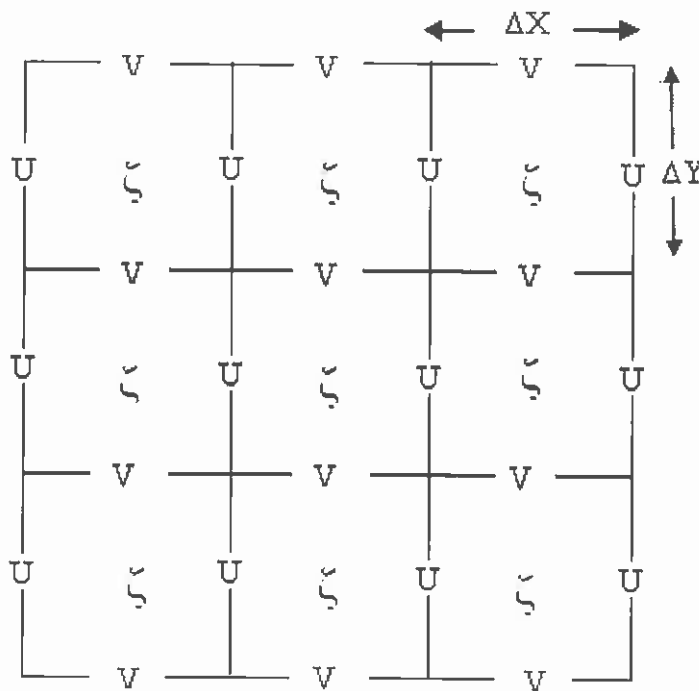

Fig.(3) The Arakawa - C finite difference grid

very strong currents in semi-enclosed bodies of water which are produced normally by astronomical tides. (open University)

The forcing function for tide-driven circulation is provided by the semi-diurnal oscillation of the sea-level at opening of Sirte Gulf. Following mathematic principles, any continuous function which is given at every point in the interval can be represented by an infinite series of sines and cosine function. The series is called Fourier series.

The truncated Fourier series

$$\zeta_{(t)} = \zeta_{ave} + \sum_{i=1}^{i=N/2} \left[ A_i \sin\left(\frac{2\pi}{p} it\right) + B_i \cos\left(\frac{2\pi}{p} it\right) \right]$$

$$A_{(i)} = \frac{1}{N} \sum_{k=1}^N \left[ \zeta \sin\left(\frac{2\pi}{p} it_k\right) \right]$$

$$B_{(i)} = \frac{1}{N} \sum_{k=1}^N \left[ \zeta \cos\left(\frac{2\pi}{p} it_k\right) \right]$$

Where  $\zeta$  is the tidal elevation,  $N$  is the number of harmonic,  $p$  is the period of data,  $t$  is the time. The truncating Fourier series (sinusoidal function) given by this equation is then used to force the model at the northern open boundary simulating periodic flooding and ebbing at the Sirte Gulf.

Because there is no observation data in the Sirte Gulf, the data used in prescribing the open-boundary tidal elevation come from a selected seven-day period of simultaneous hourly data (the data obtained over a period of one month from predicting tide at Al Brayqah port from Admiralty EasyTide website (Admiralty EasyTide)). The semi-diurnal

oscillation of the sea level at the opening of the Gulf corresponding to seven days of predicting data is shown in fig. (4)

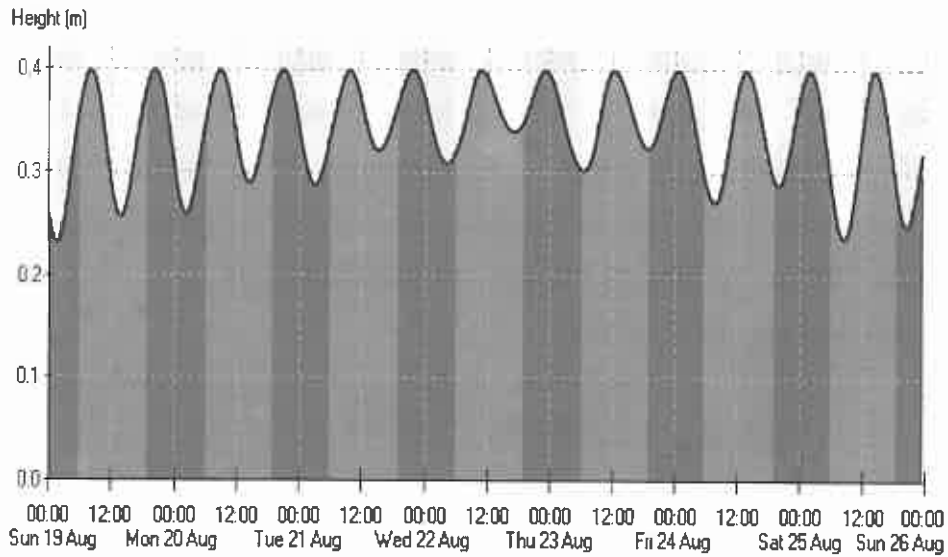

Fig.(4) predicted tide at Al Brayqah port (Admiralty EasyTide)

## Results and discussion

During the numerical experiments the following parameters were held constant. The coriolis parameter takes the value  $f = 7.728358 \times 10^{-5}$  corresponding to approximate mid-latitude of 32N, the value of bottom friction coefficient  $k = 0.003$  is a generally accepted value (e.g Flather; Mortinsea et al ; Brettschneider 1967) , Acceleration due to gravity  $g = 9.81 \text{ms}^{-2}$  , water density  $\rho_w = 1025 \text{kgm}^{-2}$ . The time step of 30 seconds is chosen to satisfy the Courant-friedrichs-lewy stability criterion

$$\Delta t \leq \frac{\Delta x}{(2gh_{\max})^{\frac{1}{2}}} .$$

The experiments performed can be divided into two separate categories: wind-driven motion and wind-tide-driven motion.

### 1- wind-driven motion

Results of numerical integration corresponding to the response of the Sirte Gulf to diurnal variation of observation wind stress without tide, distribution over one month (wind observation data every 3 hours which is taken from station of Ajdabiyah for month of August) are depicted in figures (5-12). The figures represent 48 hours of model integration. The results are obtained at 3-hourly intervals starting at (0600 GMT) in the morning. Figures (5-12) show the results of the current field induced by wind forcing. The shape of the current, represented by arrows, is quite interesting in reference to the direction of wind stress. For time 0600, no current field can be noted at this time, so we didn't present this figure. Looking at fig.(5) for time 0900 GMT, we can notice that the current coming from the middle of the Gulf towards the south diverges to the right and left towards both sides of the Gulf before it reaches the southern coastlines, forming two gyres with anticlockwise and clockwise circulations respectively, with a maximum wind speed of  $5\text{ms}^{-1}$ . Within each circulation, the current speed is weak in the centre while the current speed near the southern coastlines has a minimum speed.

In fig.(6) the current speed is changed little at some points although the maximum current speed remains approximately the same.

---

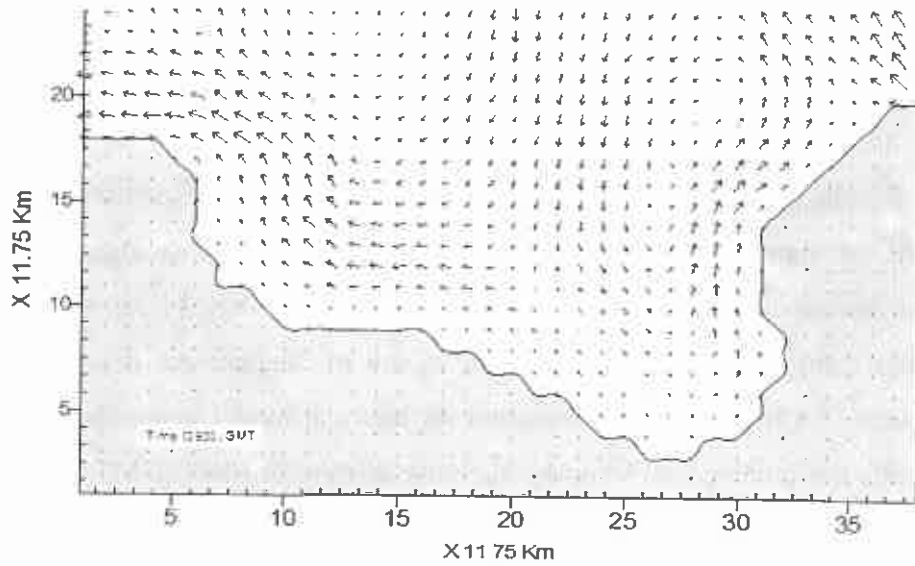

Fig.(5) The generation of current in Siret Gulf by wind. Max. Current (5) m/s

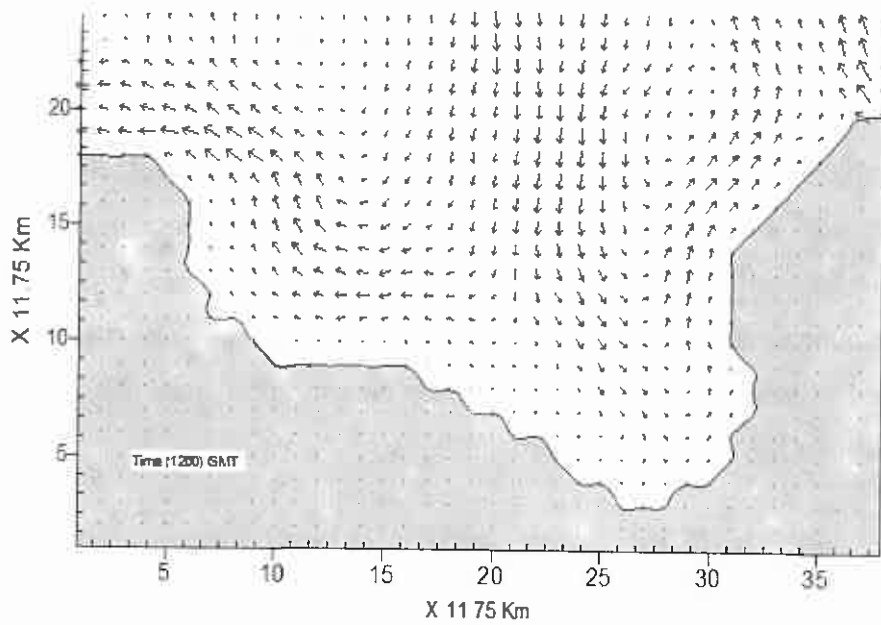

Fig.(6) The generation of current in Siret Gulf by wind. Max Current (5.1) m/s

fig. (7) shows that centre of the right gyre moved toward the right coastline and the current speed on the left side of the gyre is stronger than that on the right near the coast while the left gyre starts to dissipate and lose its shape and the current curves parallel to the left boundaries.

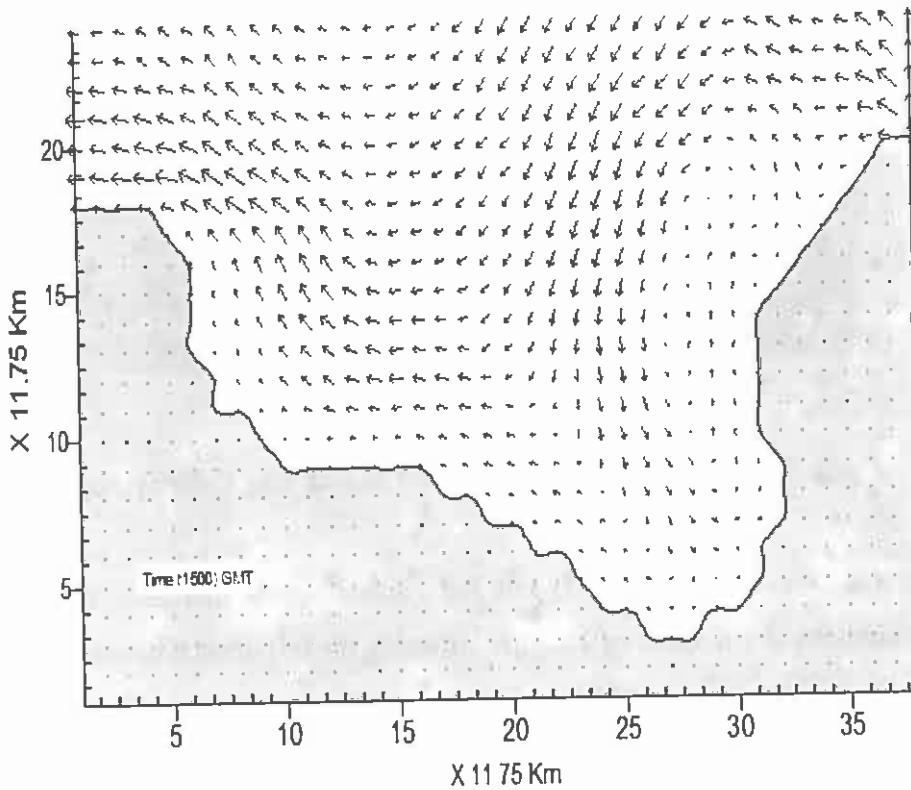

Fig.(7) The generation of current in Sirte Gulf by wind. Max. Current (7.8) m/s

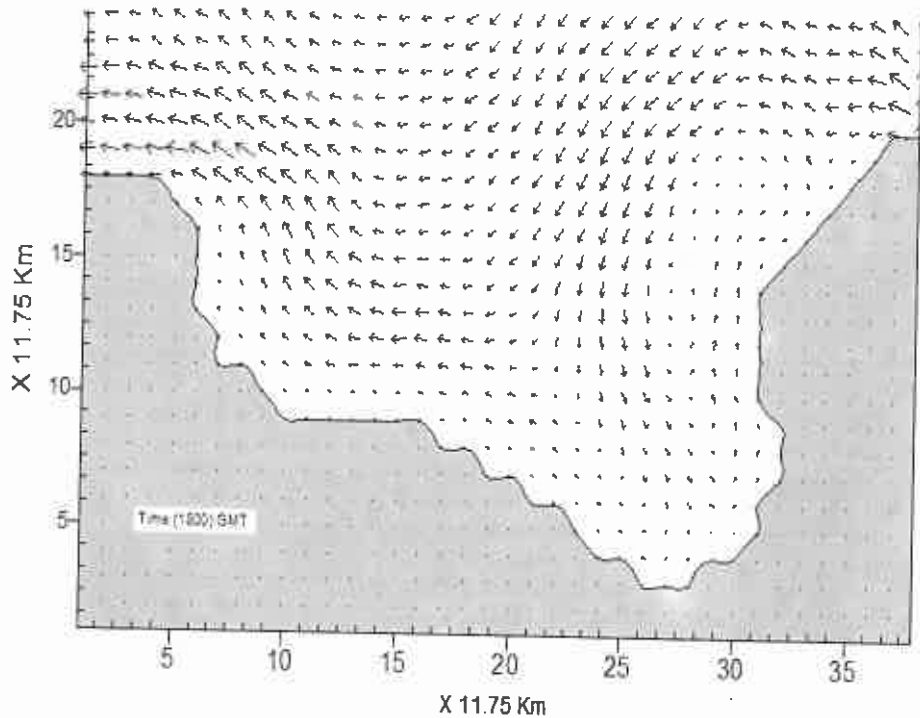

Fig.(8) The generation of current in Siret Gulf by wind. Max. Current (12.3) m/s

fig. (8) is similar to fig. (7) but the current speed increases to reach maximum current speed of  $12.3 \text{ ms}^{-1}$  towards the left open boundaries.

In fig. (9) the current speed increases to reach a maximum speed of  $14.7 \text{ ms}^{-1}$  and the right gyre starts to disappear completely.

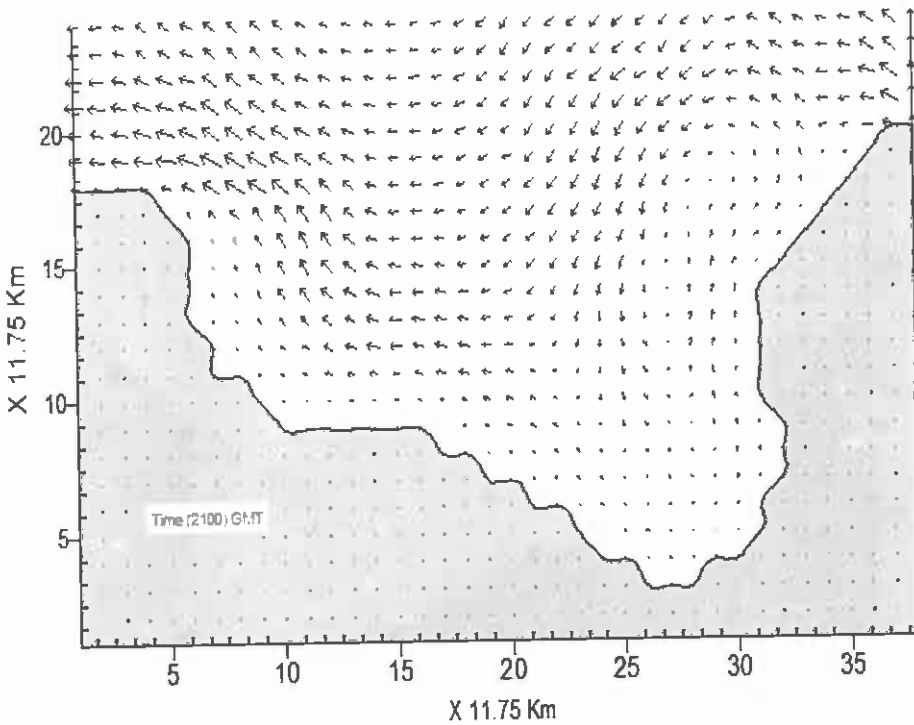

Fig.(9) The generation of current in Siret Gulf by wind. Max. Current (14.7) m/s

fig. (10) the current flows from the right open boundaries toward the centre of the Gulf where it changes its direction toward the southern coastlines before it reaches these lines it changes its direction towards the left open boundaries with a max. current speed  $12.8 \text{ ms}^{-1}$  taken the shape of the Gulf while the current speed near the right coast lines and the right part of the southern coastlines is minimum.



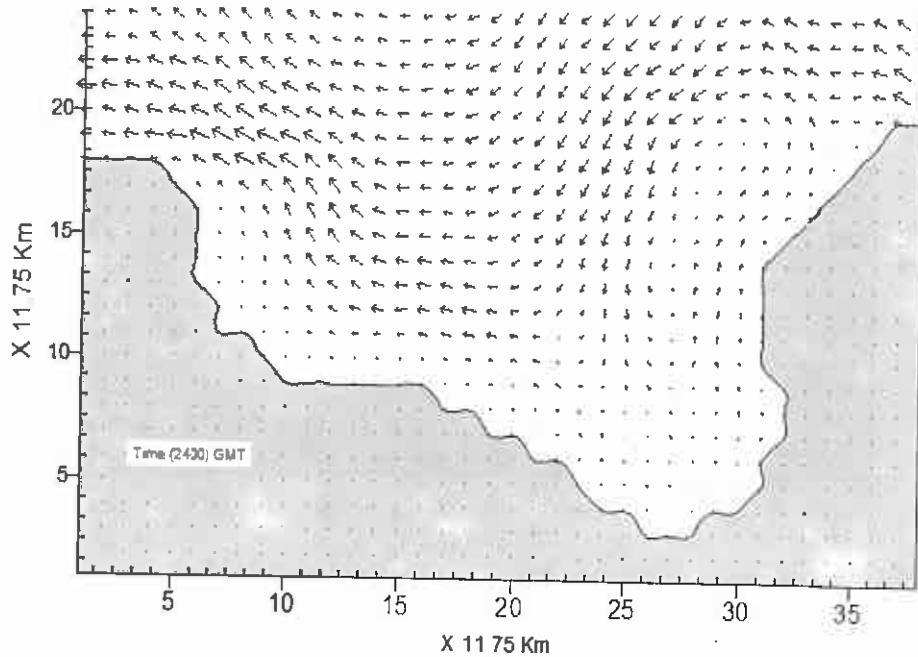

Fig.(10)The generation of current in Siret Gulf by wind. Max Current (12.8) m/s

fig. (11) is not different from fig. (10) but the current speed decreases to  $10.3 \text{ ms}^{-1}$  representing the generation of current on the next day. And in fig. (12) the current speed is further decreased to about ( $7.7 \text{ ms}^{-1}$ )

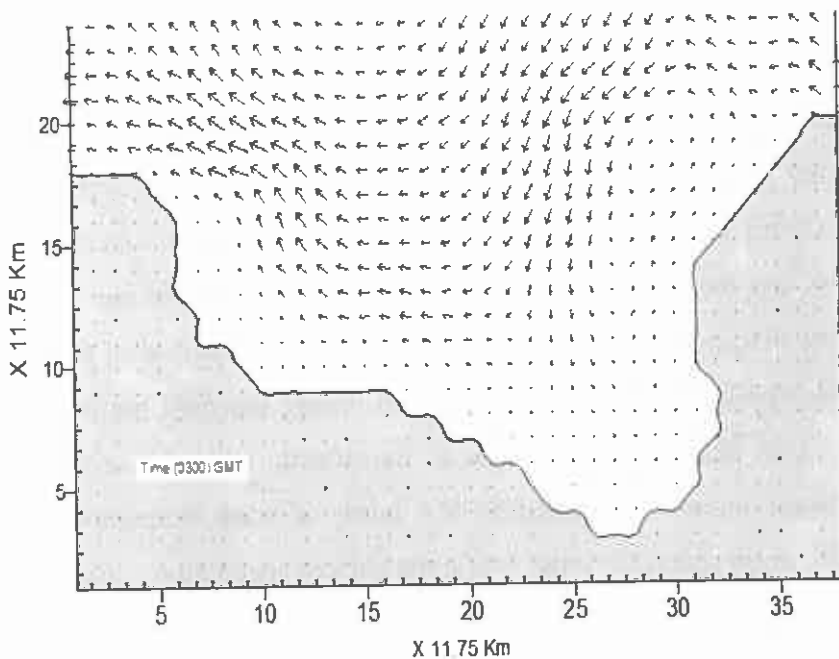

Fig (11) The generation of current in Siret Gulf by wind, next day Max. Current (10.3) m/s

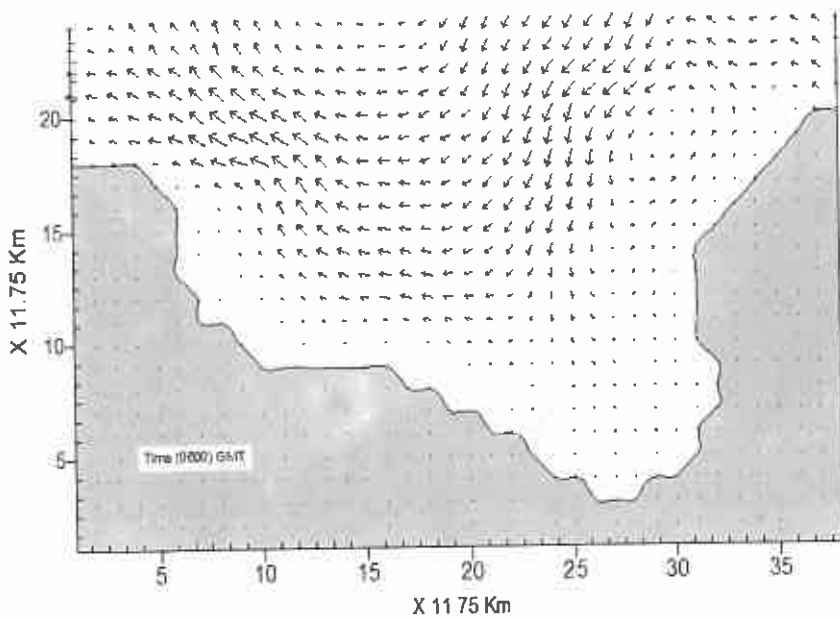

Fig.(12) The generation of current in Siret Gulf by wind, next day. Max. Current (7.7) m/s

## 2- wind-tide driven motion

In the presence of tide forcing it is of interest to note that the combination between wind stress and tide forcing results into new features that is different from that of wind stress when acted separately. Figures (12-16) show the generation of current due to combination of wind stress and the semi-diurnal tide oscillation. Following these figures we can note that incoming tide (flood tide) persist for a period of 6 hours this is followed by outgoing tide (ebb tide) during the next period of 6 hours. fig. (13) illustrates the outflow of the domain and we can see the strong current increases forward to the north of open boundary with maximum current speed  $19.6 \text{ ms}^{-1}$  while the current speed along coastlines is weak. fig. (14) and (16) for 1500 GMT and 0300 GMT next day, we can see the current inflow through the open boundary with current speed  $29.2 \text{ ms}^{-1}$  and  $39.5 \text{ ms}^{-1}$  respectively. fig. (15) and (17) we can see the current outflow convergence occurs

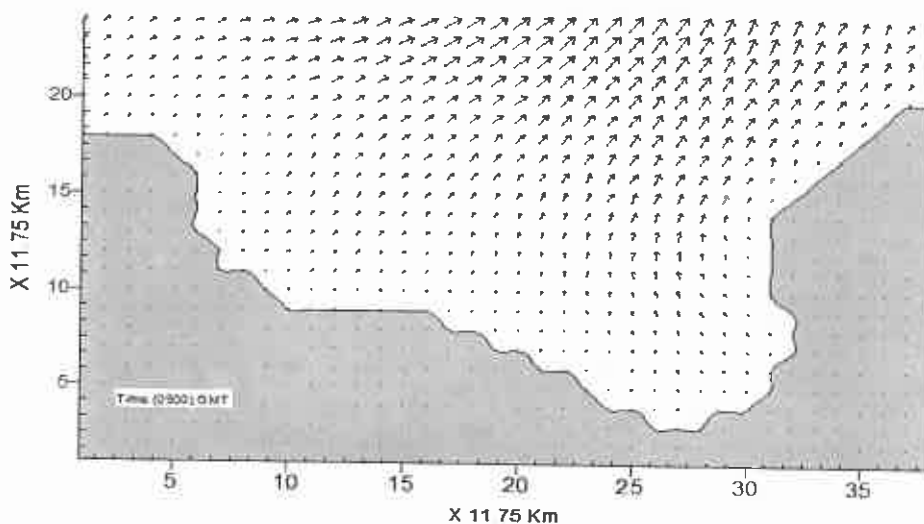

Fig.(13) The generation of current in Siret Gulf by combination of tide & wind  
Max. Current speed ( $19.6 \text{ m/s}$ )

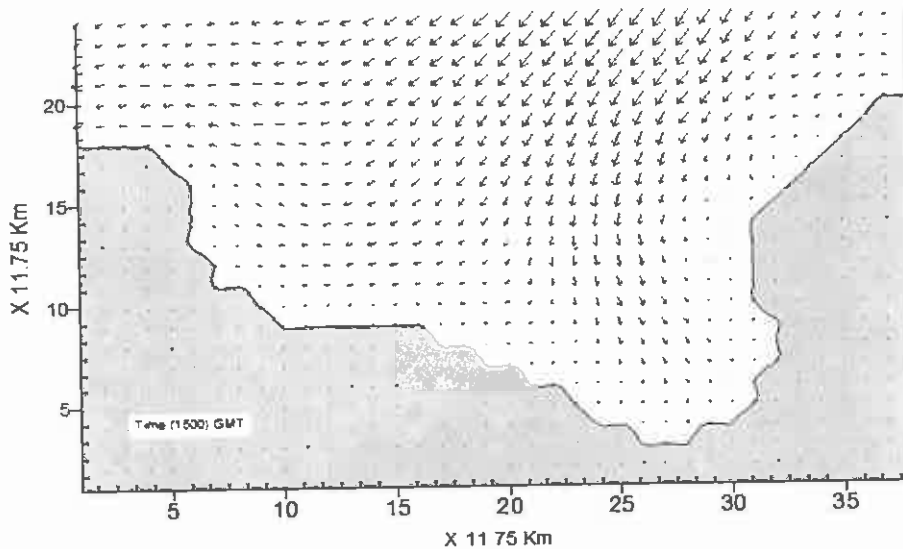

Fig (14) The generation of current in Siret Gulf by combination of tide & wind.  
Max. Current speed (29.2) m/s

in the middle open boundary with maximum current speed  $19.8 \text{ ms}^{-1}$  and  $27.7 \text{ ms}^{-1}$  and the current along the coastal is weak.

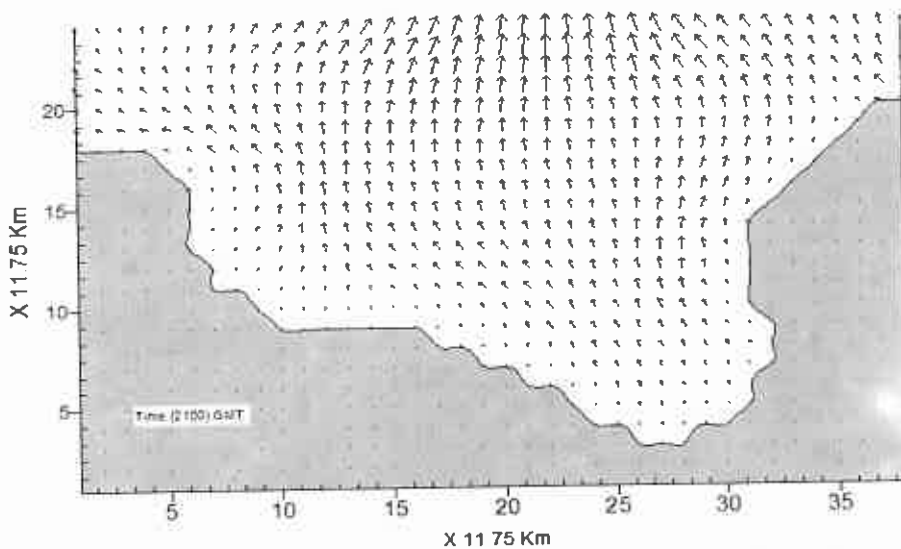

Fig.(15) The generation of current in Siret Gulf by combination of tide & wind.  
Max. Current speed (19.8) m/s

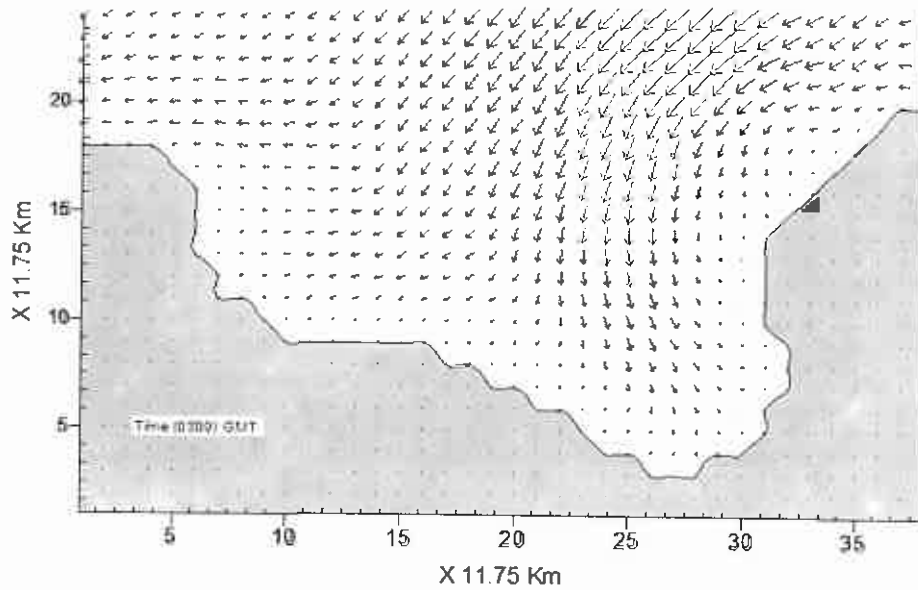

Fig (16) The generation of current in Sert Gulf by combination of tide & wind.  
Max. Current speed (39.5) m/s

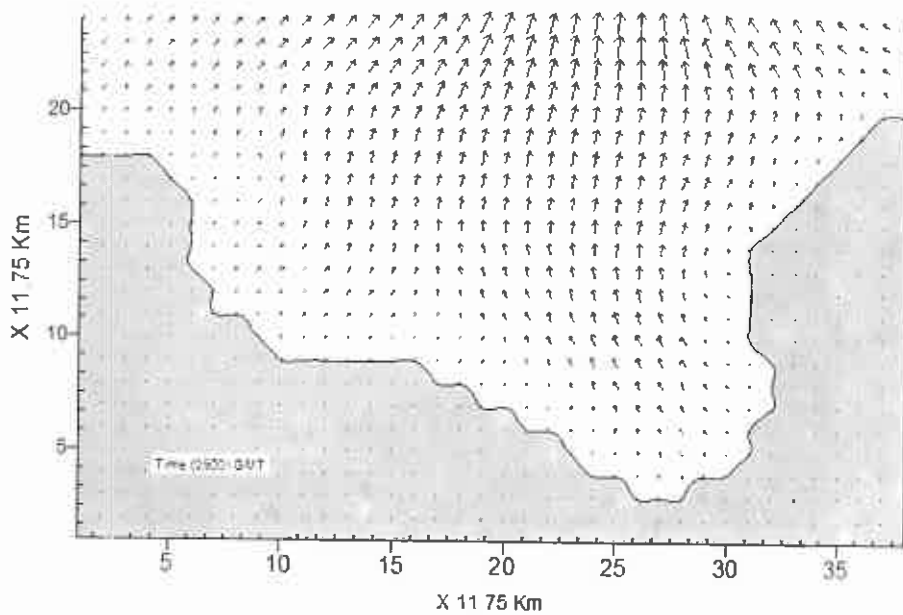

Fig (17) The generation of current in Sert Gulf by combination of tide & wind,  
next day Max. Current speed (27.7) m/s

## Summary

In this paper we used a vertically integrated hydrodynamic model to study the influence of wind stress without tide forcing and the combination of wind stress and tide to generate current in the gulf of Sirte. The results show that the current near the coastlines is weak in both cases when the current generated by pure wind or the current generated due to combination of wind stress and tide forcing

The current in the centre of the domain or farther somewhat is strong and its direction is changing depending on the effect of wind stress direction also the current speed which is generated by combination of wind stress and tide forcing is higher than the current speed generated by wind stress.

## مستخلص

### نموذج دراسة نظرية للتيارات البحرية في خليج سرت

يتميز خليج سرت بموقع بالغ الأهمية في الجماهيرية الليبية حيث تقع معظم الموانئ البحرية النفطية والتجارية على ساحله. وانطلاقاً من تلك الأهمية لابد من دراسة التيارات البحرية فيه. لذلك تم تطبيق نموذج (vertically integrated hydrodynamic model) لدراسة توليد التيارات في الخليج مرة بواسطة إجهاد الرياح ومرة أخرى بواسطة إجهاد الرياح بالإضافة إلى المد (Tide) الذي اعتمد على بيانات متوقعة لعدم توفر البيانات الفعلية.

يبين النتائج بان التيارات بكلاً الحالتين تكون قوية عند منتصف الخليج وعند المناطق البعيدة بعض الشيء عن الساحل وتكون ضعيفة على طول امتداد الساحل

## Reference

- Admiralty EasyTide, <http://easytide.ukho.gov.uk>
- Alan M. Davies, 1988 : on formulating two-dimensional vertically integrated hydrodynamic numerical model with an enhanced representation of bed stress. *J. of Gophy. Res.* Vol. 93 no.C2 1241-1263
- Al\_hadi Abuluqma, Fatthi Al\_haram. Atlas of education for elementary school. General People Committee for Education , The Great Socialist Peoples Libyan Arab Jmahiriya
- Brettschneider, G. (1967). Anwendung des Hydrodynamischnumerischen Verfahrens zur Ermittlung der  $M_2$  -Mitschwingungszeit der Nordsee. Insituts für Meereskunde, Universit?t Hamburg, Mitteilungen Nr 7
- Fandry, c. B. 1981. Development of a numerical model of tidal and wind-driven circulation in Bass Strait. *Aus.J.Mar. Freshwater Res.*, 32:9-29
- Fandry, c. B. 1982. A numerical model of the wind-driven motion in Bass Strait. *J. Geophys. Res.*, 87:499-517
- Fandry, c. B. 1983. Model for the three-dimensional structure of wind-driven and Tidal circulation in Bass strait. *Aust. J. Mar. freshwater Res.* 34,121-41
- Flather, R. A. (1976a). A tidal model of the north-west European continental shelf.  
Mem. Soc. R. Sci. Liege Vol. Hors Ser. 6 10,141-64
- Great world atlas ; prepared and published by the readr's digest association  
limited. Plannel under the direction of the late Frank Debnham
-

- Inoue, M., W. J. Wiseman, Jr., and D. Park. 1998. Coastal marine environmental modeling. U.S. Dept. of the Interiors, Minerals Management Service, Gulf of Mexico OCS Region, New Orleans, Louisiana. OCS Study MMS 98-0052. 133 pp
- Inoue, M. and W. J. Wiseman, Jr. 2000. Transport, stirring and mixing process in a Louisiana estuary: A model study. *Estuarine, Coastal and Shelf Science*, 50:449-466.
- Inoue, M., W. J. Wiseman, Jr., D. Park, D. Justice, and G. Stone. 2001. Dispersion in broad, shallow estuaries: A model study. U.S. Dept. of the Interior, Minerals Management Service, Gulf of Mexico OCS Region, New Orleans, Louisiana. OCS Study MMS 2001-054. 54 pp.
- International chart series Mediterranean sea 1993 published at Tunton 22<sup>nd</sup> July 1988 under the superintendence of Rear-Admiral R.O Morris. Hydrographer of the Navy
- Jelesnianski c.p.,1965 A numerical calculation of storm tides include by a tropical storm impinging on a continental shelf. *Mon. Wea. Rev.*, 93:343-358
- Jelesnianski c.p.,1966. Numerical computation of storm surges without bottom stress. *Mon. wea. Rev.* , 94: 379-395
- Jelesnianski c.p.,1967. Numerical computation of storm surges with bottom stress. *Mon. wea. Rev.* 95: 740-756.



- 
- Jelesnianski c.p.,1970. Bottom stress time-history in linearized equation of motion for storm surges. *Mon. wae. Rev.* , 98: 462-477.
- Marino A. Estoque 1997. A costal current in linganen Gulf in Relation to pollution from A Marine outfall . first Annual Report submitted to the national research council of the philippinel NRCP Project No. L-34
- Martinsen, E. A. , Gjerik , B., and R?ed L.P.(1979). A numerical model for long barotropic waves and storm surges a long the western coast of Norway. *J. Phys. Oceanogr.* 9.1126-38
- Mohamed M. Al-Mahdy, Human Geography of Libya , Benghazi , publications of University . of caryonis 1990
- Park, D. H. 1998. A modeling study of the Barataria Basin system. M.S. thesis,  
Louisiana State University, Baton Rouge, Louisiana. 133 pp.
- Park, D., Inoue, M., William J. Wiseman, Jr., Justic, D , Ston, G. 2004. High-Resolution Integrated Hydrology-Hydrodynamic Model: Development and Application to Barataria Basin, Louisiana , Coastal Marine Institute, OCS Study MMS 2004-063
- Salem Ali Hajjaji , 1989: the new Libya. Press Alfateh for universities
- Thomas H. A. Duhaut and David N. Straub,2006, Wind Stress Dependence on Ocean Surface Velocity: Implications for Mechanical Energy Input to Ocean Circulation: *Journal of Physical Oceanography*, volume 36 : pp. 202–211
-